

組立完成図

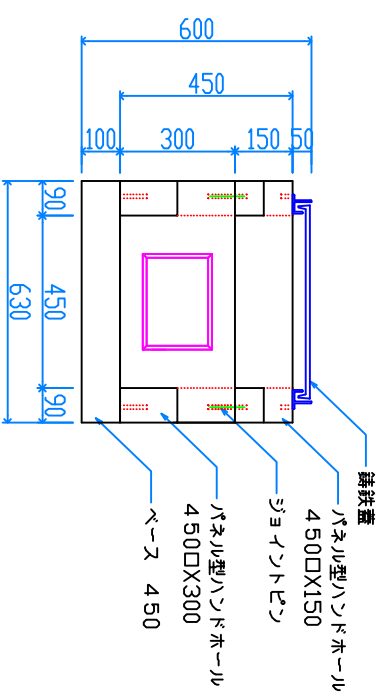

パネル型ハンドホール 450

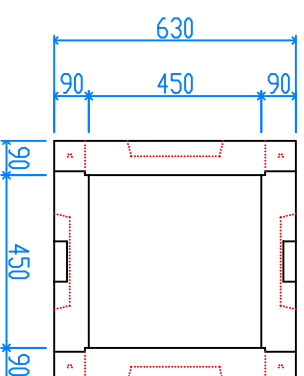

H-300  
29kg X 4

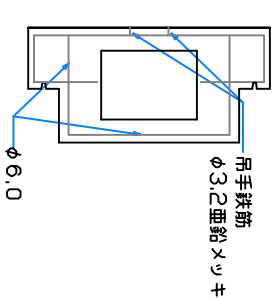
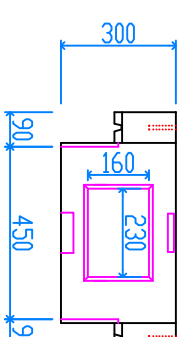

H-150  
17kg X 4

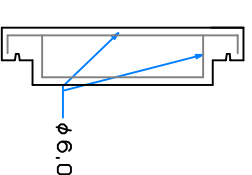
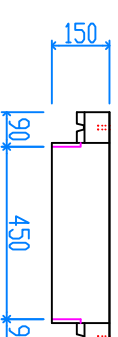

組立参考図

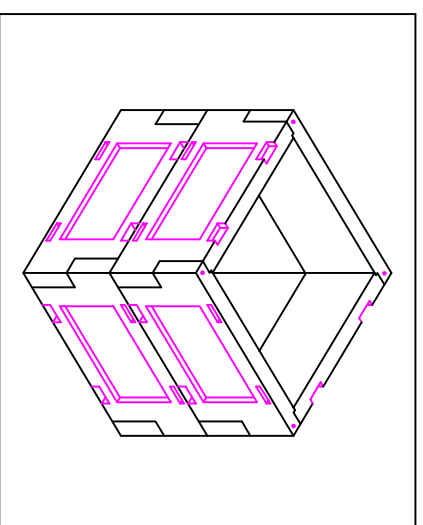

ペース 450  
97kg

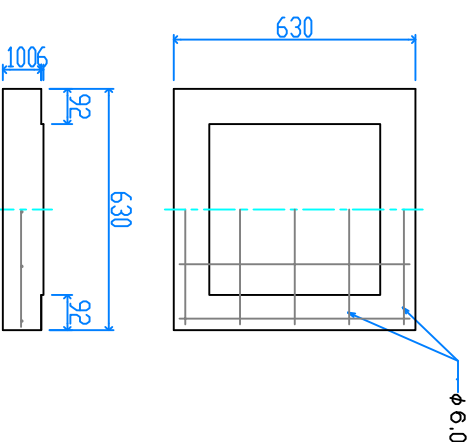

名称	パネル型 450□X450			
品番	U4545B			
総重量	281kg			
備考				
作成日	H26.7.8	縮尺	1/20	